

QUESTIONS OR CONCERNS CONTACT CANARM AT:
1-800-265-1833 (English) • 1-800-567-2513 (French)
Monday through Friday 8:00 AM to 5:00 PM E.S.T.



"INSTRUCTIONS PERTAINING TO RISK OF FIRE OR INJURY TO PERSONS"
"READ ALL INSTRUCTIONS"
"IMPORTANT SAFETY INSTRUCTIONS"
"SAVE THESE INSTRUCTIONS"

SAFETY PRECAUTIONS:

1. TURN OFF ELECTRICAL POWER BEFORE STARTING INSTALLATION OF LIGHT FIXTURE.
 2. THIS PRODUCT MUST BE INSTALLED IN ACCORDANCE WITH THE APPLICABLE INSTALLATION CODE BY A PERSON FAMILIAR WITH THE CONSTRUCTION AND OPERATION OF THE PRODUCT AND THE HAZARDS INVOLVED.
- NOTE: Product May Not Look Exactly As Shown In Figures.**

INSTALL EASY CONNECT MOUNTING BRACKET:

STEP 1

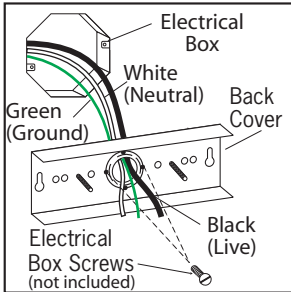

Attach easy connect mounting bracket to electrical box with electrical box screws (not included).

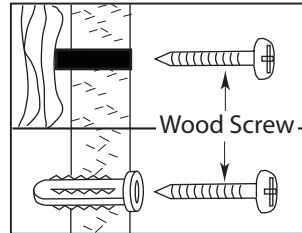

Additional support may be required for fixtures longer than 20". Position the fixture and add wood screws (one on each side) for the wooden studs or plastic wall anchor and wood screws for dry wall.

CONNECT HOUSE WIRES

STEP 2 - Option 1

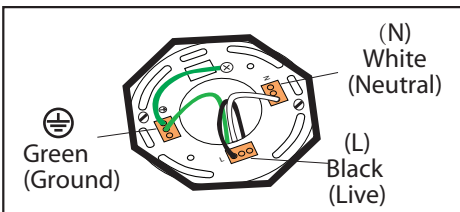

Connect (push) electrical wires from electric box (house wiring) into correct inserts. Black (Live), White (Neutral), Green (Ground)

Option 2 - MULTIPLE ELECTRICAL BOX WIRES

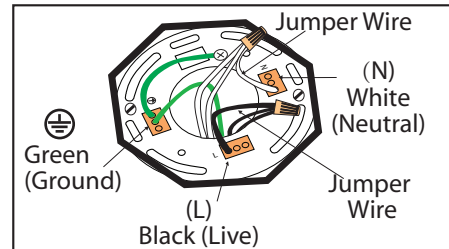

For multiple black (live) & white (neutral) wires joined in the electrical box (house wiring), attach a single "black" and "white" Jumper Wire before connecting. Strip 7mm from a 6" Jumper Wires (AWG 12-24) supplied. Then connect (push) wires into correct inserts.

CONNECT LIGHT FIXTURE

STEP 3

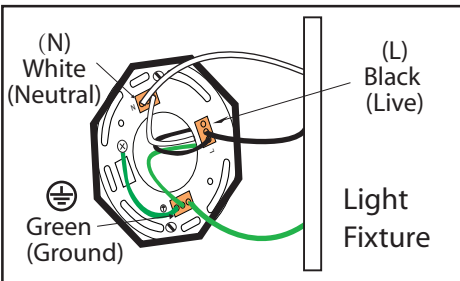

Connect (push) electrical wires from fixture into correct inserts. Black (live), White (neutral), Green (ground)

STEP 4

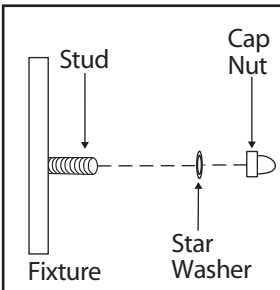

Tuck electrical wires into outlet box and position fixture over studs on mounting bracket assembly. Secure fixture in place with star washers and cap nuts.

Note: If required, assemble body and spread the arms of the fixture out evenly.

STEP 5

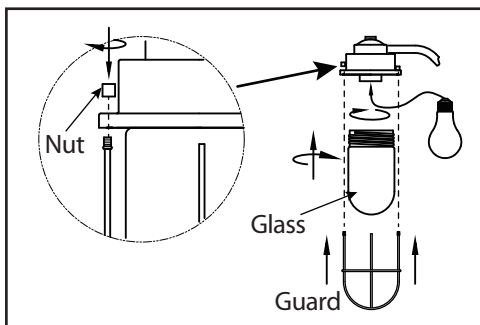

Install the proper bulb type and wattage (not included).
Screw glass cylinder on to the fixture.
Install the guard with the nuts.